



Operator Manual

NA 9328 Prof XL pump



Win Equipment B.V.
De Kronkels 31
3752 LM Bunschoten
The Netherlands

Tel.: + 31 (0)33 299 22 66
E-mail: service@nissei.nl

Contents

Contents	3
1 Introduction	5
1.1 Purpose	5
1.2 Manufacturer	5
1.3 Machine identification	6
1.4 Warranty	6
1.5 Accessories	6
1.6 Liability	7
1.7 Copyright	7
2 Safety	8
2.1 Symbols used in this manual	8
2.2 Emergency stop	8
2.3 Safety symbols on the machine	8
2.4 Safety instructions	10
2.5 Operation and maintenance	11
2.6 Hygiene	11
2.7 Storage	11
3 Installation	12
3.1 Introduction	12
3.2 Installation site	12
3.3 Electrical connection	12
3.4 Connection of cooling water	13
4 Machine Description	14
4.1 Function and products	14
4.2 Machine overview	14
5 Operation	17
5.1 Start up (start of working day)	17
5.2 Dispensing soft ice cream	18
5.3 Switching off (end of working day)	19
Switching off & standby	19
Switching off & pasteurising	20
5.4 Emergency stop	20
5.5 Switching on/off	21
5.6 Adjusting the viscosity	21
6 Faults	22
6.1 Introduction	22
6.2 Messages on display	22
6.3 How can I get the best yield from the machine	23

	How can I check whether the XL pump is not causing a malfunction	23
	What should I do with a soft or wet and watery ice cream	23
	What should I do in case of rasping, popping or if the machine displays LO	24
6.4	Faults table	25
7	Maintenance	27
7.1	Safety instructions	27
7.2	General instructions	27
	Requirements	28
	Preventive maintenance	28
	Cleaning and disinfecting	29
	Decalcify	30
7.3	(Dis)assembling, cleaning and disinfecting the machine.	30
	Procedure	30
	Defrosting and draining cylinder	31
	Removing XL pump and mix tank agitator	32
	Draining the mix tank.	32
	Cleaning the mix tank and cylinder	33
	Decalcify the machine	35
	Removing the ice cream head	36
	Disassembling, cleaning and disinfecting the ice cream head	37
	Fitting the ice cream head.	38
	(Dis)assembling, cleaning and disinfecting the cylinder beater	39
	Fitting the ice cream head.	40
	Disinfecting the machine.	41
	(Dis)assembling, cleaning and disinfecting the XL pump	41
	Starting up the machine	45
8	Transportation and Storage	47
8.1	Transportation	47
8.2	Storage.	47
9	Discarding	48
9.1	Environmental factors	48
Annex 1	Specifications	49
Annex 2	Spare Parts	50
A2.1	Ice cream head and beater.	50
A2.2	XL pump.	52
Annex 3	EC Declaration	54

1 Introduction

1.1 Purpose

The purpose of this Operator Manual is to provide the operator with information relating to the use and maintenance of the NA 9328 Prof XL pump.



Read this Operator Manual carefully before using the machine.

1.2 Manufacturer

Win Equipment B.V.
De Kronkels 31
3752 LM Bunschoten
The Netherlands





Dealer mark



1.3 Machine identification

The machine plate is affixed to the rear of the machine. This plate carries the CE mark. This means that the machine meets the basic health and safety requirements of the European Union.

 		NISSEI FREEZER	
		Hermetically sealed system contains fluorinated greenhouse gases.	
MODEL	NA9328WEG	R404A charge	530 Gram
SERIAL NR.	B6170001	GWP	3922
POWER 50Hz	400 V ; 3 Phase	CO ₂ equivalent	2,078 Ton
Dasher motor	550 W	Test pressures:	
Compressor	750 W	High side	2.1 MPa
Consumption	3.0 A	Low side	1.5 MPa
MANUFACTURER :		IMPORTER E.U. :	
NISSEI COMPANY LTD		WIN EQUIPMENT B.V.	
2-11 3-CHOME HAGINOSHO, TAKATSUKI-SHI, OSAKA-FU, 569-0093 JAPAN		De KRONKELS 31 3752LM BUNSCHOTEN the NETHERLANDS	



This machine contains fluorinated greenhouse gases in a hermetically sealed system with the values as specified in the label.

1.4 Warranty

The dealer offers on new machines a 5-year warranty on expensive parts and a 12-month warranty on non-wearing parts and repair costs. This is in accordance with the conditions specified in the order confirmation.

1.5 Accessories

The following items are supplied with the machine:

- Operator manual
- O ring remover
- Piston puller
- Cleaning brush, narrow and wide
- Tube of lubricant (Petrogel)
- O ring replacement set
- Set of fuses
- Set of nozzles

1.6 Liability

The dealer is not liable for any unsafe situations, accidents and/or damage resulting from any of the following points:

- Failure to observe warnings or instructions as displayed on the machine or in this Operator Manual.
- Use of the machine for applications or under conditions other than those specified in this Operator Manual.
- Changes of kind made to the machine. This also includes the use of different replacement parts.
- Inadequate maintenance.

Win Equipment B.V. is not liable for any consequential damage due to machine faults, such as damage to products, business interruptions, production loss etc.

1.7 Copyright

Copyright © 2018 Win Equipment B.V.

All rights reserved.

No part of this publication may be copied, stored in an automated data file or made public, in any form or in any way, be it electronically, mechanically, by photocopy, recording or in any other way, without the prior written consent of the manufacturer.

2 Safety

2.1 Symbols used in this manual.

Below you will find an explanation of the symbols that may be used in this manual to draw the attention of the reader to particular situations.



Wees voorzichtig:

- er kan zich een ongeval voordoen of;
 - er kan schade aan de machine ontstaan.
- Niet doen!**



Aandachtspunt of suggestie om taken of handelingen makkelijker uit te voeren.



Doorlezen van hetgeen aangegeven wordt is belangrijk.



Wachten voordat met de volgende handeling verder kan worden gegaan.

2.2 Emergency stop

The emergency stop button must be pressed immediately if people or machinery are at risk.

The entire machine stops immediately and the power is turned off. The emergency circuit is now in operation.

The operation of the emergency stop is described in chapter 5.4 - 'Emergency stop'.



Use the emergency stop button immediately if people or machinery are at risk.



People who operate the machine must be informed about the operation and location of the emergency stop button.

2.3 Safety symbols on the machine

The following safety symbols have been affixed to the machine:

Location of emergency stop.

This symbol is affixed to the left front side of the machine above the emergency stop button.



Risk of trapping hand.

This symbol is affixed to the top of the machine next to the mix tank.



Do not spray with water.

This symbol is affixed to the rear of the machine next to the ventilation slots.



Danger: electricity.

This symbol is affixed inside the housing.

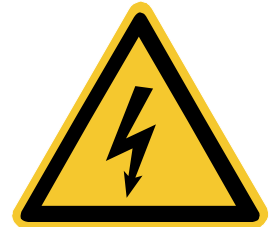

2.4 Safety instructions

The machine meets the basic health and safety requirements of the relevant directives of the European Union.

Improper or careless use can lead to dangerous situations. Please observe the following general safety instructions:

- Connect the machine in accordance with the basic health and safety requirements of the relevant European directives.
- Exercise caution with loose hair and clothing.
- Keep your hands away from dangerous zones.
- Never power up the machine if people are in contact with it.
- Pull the plug out of the socket before carrying out maintenance work on the machine.
- Faulty safety equipment must be replaced before the machine is used in production.
- The machine must be maintained in accordance with the instructions found in chapter 7 - 'Maintenance' on page 27.
- Changes to the machine must not be implemented without the prior consent of the manufacturer.
- The safety equipment of the machine must be checked weekly for correct operation.
- Never remove the machine's plating. There are no parts that you can replace or adjust yourself.
- Do not remove or cover any labels on the machine.



The safety instructions specified in this document must be observed. Deviating from the instructions can cause unacceptable risks.

2.5 Operation and maintenance

The machine may only be operated, maintained and cleaned by trained staff. The end user determines the basis on which staff are authorised for this purpose.

2.6 Hygiene

Good hygiene is very important. Please adhere to the following rules:

- **Clean and disinfect** the machine at least according the hygiene code ice making but at least once every 6 weeks
- **Decalcify** the machine every 2nd till 4th cleaning depending on the pollution, but at least twice a year.
- **Use** the recommended cleaning, disinfecting and decalcify agents to ensure an optimum result.
- **Use** prescribed lubricants only.



Good hygiene ensures better ice cream and satisfied customers.



The operator always remains responsible for good hygiene.

2.7 Storage

To prevent the machine being damage due to frost the machine must always be stored by a temperature between 4°C and 50°C when it is not used.



Prevent damage by frost. Store the machine when it is not used by a temperature between 4 °C and 50 °C .

3 Installation



Read this chapter carefully before installing the machine. This is the only way to ensure maximum safety.

3.1 Introduction

The manufacturer carries out the initial installation. When moving the machine you are advised to contact the dealer.



The machine may only be installed by qualified personnel.

3.2 Installation site

- DO NOT place the machine outside.
- Place the machine on a firm, flat surface (to prevent noise and vibration).
- Keep 10 cm free at the rear and 2 cm at the sides for ventilation.
- Do not place the machine in direct sunlight (not even behind glass) or near to a heat source (e.g. radiator or deep fryer).
- Place the machine in a room with a temperature between +5°C and +35°C.

3.3 Electrical connection

- Connect the plug of the machine to a high-voltage power supply (400 volts, 3 x 16 amps + N + PE).



When setting up the machine, make sure it is not positioned on the connection cable. This can damage the insulation and lead to a short-circuit.

3.4 Connection of cooling water

- Connect the supply hose to a washing machine tap (3/4'' water tap with ventilation). The water pressure must be a minimum of 1 bar and a maximum of 3 bar.
- Connect the discharge hose to the discharge pipe.



When connecting, please observe the local water board connection conditions.

The machine has a check valve. This valve along with aerated faucet prevents the backflow of water into the water supply.



When setting up or moving the machine, make sure that the water supply and discharge hoses cannot bend or otherwise become blocked.



Make sure that no water can enter the machine. If water comes into contact with electrical parts, this can cause damage and/or danger.

4 Machine Description

4.1 Function and products

The machine is only suitable for the commercial preparation of soft ice cream using water and ice cream mix as ingredients.

4.2 Machine overview

1. Operating panel
2. Air light
3. Air button
4. Emergency stop
5. Refresh button
6. Ice cream head
7. Mix tank with water tap

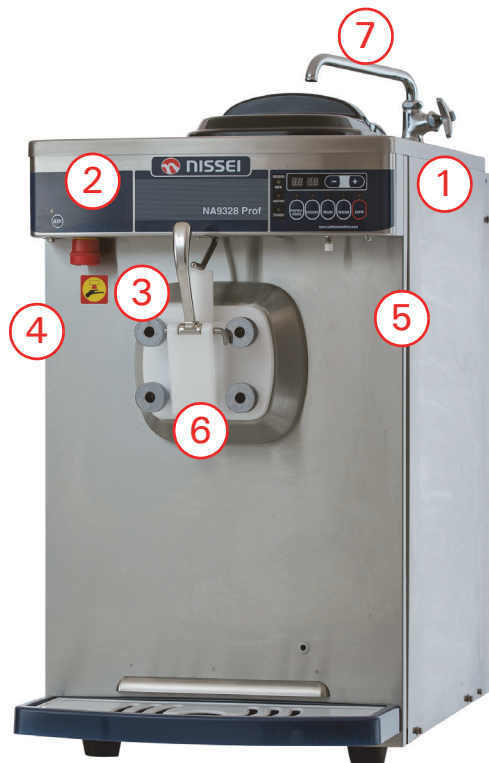

Air

Pressing in the button switches the air compressor on and off. The light comes on when activated.



'AIR' must always be switched on in operating mode.

Operating panel

- **OFF**
Press to switch off the machine; only the lights remain lit.



First press 'OFF' before changing the mode.



- **PASTEURISING**
Sets the machine to pasteurising mode. The ice cream mix in the cylinder and mix tank is pasteurised and the machine then switches to standby mode.
- **STANDBY**
Sets the machine to standby mode. The cylinder and mix tank are cooled to approx. 5°C.
- **RUN**
Sets the machine to operating mode. Ice cream can be dispensed.
- **WASH**
Sets the machine to wash mode and switches on the mixing apparatus in the cylinder.
- **- and +**
Selection keys to reduce and increase viscosity.
- **REPLENISH**
Control light; flashes YELLOW if there is insufficient ice cream mix in the mix tank.
- **HEATING**
Control light; lights up RED during pasteurising.
- **STANDBY**
Control light; lights up GREEN if the machine is in standby mode.

Ice cream head

1. Soft ice cream dispensing handle
On the underside of the ice cream head you will find:
2. Soft ice cream dispensing spout.

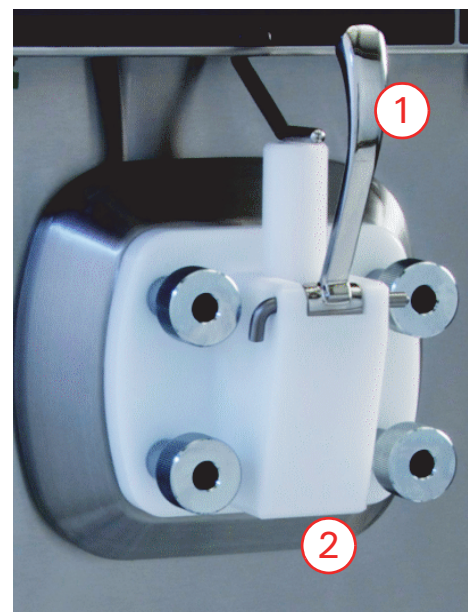

Buffet operation (optional)

1. Camouflaged buffet button.

The selection buttons only work if they are pressed simultaneously with the buffet button.

The buffet button prevents customers to operate the machine unintended.



Mix tank

1. XL pump
2. Mix tank agitator
3. Air hoses











5 Operation

5.1 Start up (start of working day)



First check whether the machine is in 'STANDBY' mode. If this is not the case, measure the temperature of the mix in the mix tank. If the temperature is higher than 7°C, empty, clean and disinfect the machine (see chapter 7 - 'Maintenance' on page 27) If the temperature is lower than 7°C, first pasteurise the machine before use.



		
<p>1. Check whether the machine is in 'STANDBY' mode. If this is not the case, measure the temperature of the mix in the mix tank. If the temperature is higher than 7°C, empty, clean and disinfect the machine (see chapter 7 - 'Maintenance' on page 27). If the temperature is lower than 7°C, first pasteurise the machine before use.</p>	<p>2. Press 'OFF'.</p>	<p>3. Press 'WASH'.</p>
 <p>10 min</p>		
<p>4. Wait at least 10 minutes.</p>	<p>5. Press 'OFF'.</p>	<p>6. Press 'RUN'.</p>

		
<p>7. Wait until 2 horizontal lines are shown in the left display.</p>	<p>8. Dispense one or two ice creams, taste them and throw them away. The machine is now ready for use.</p>	



Starting the machine after cleaning is described in chapter 7 - 'Maintenance' on page 27.

5.2 Dispensing soft ice cream

		
<p>1. Hold an ice cream cup or cone under the ice cream dispensing spout.</p>	<p>2. Pull the ice cream handle down fully. The ice cream is now dispensed.</p>	<p>3. Push the ice cream handle up fully.</p>

Tips

Here are a few tips for dispensing soft ice cream properly:

- If no ice cream has been dispensed for a while, briefly press the 'refresh button' first before dispensing ice cream.
- A good balance between air and ice cream mix in the cylinder improves the quality of the soft ice cream.
- Dispense soft ice cream carefully at a steady, constant dispensing rate.
- Do not dispense large amounts of soft ice cream in succession.
- Give the machine the opportunity in good time to bring the viscosity of the soft ice cream up to the required level again.

5.3 Switching off (end of working day)

The machine is not switched off in the same way each day. A choice can be made between switching off & standby and switching off & pasteurising.

Instructions for pasteurising



The Dutch hygiene code gives the following guidelines for pasteurising:

- Pasteurising takes place after the mix has been topped up.
- Always allow the machine to pasteurise at the end of the day.
(with a low turnover rate, pasteurise at least every two days)
- Before starting work, check that pasteurisation has been performed correctly.
- Do not keep pasteurised mix for longer than 72 hours.
- Store mix at a temperature of 7°C or lower; preferably 4°C or lower.



Win Equipment B.V. advises you to follow the above guidelines.

5.3.1 Switching off & standby

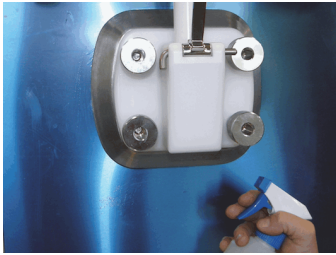
		
<p>1. Press 'OFF'.</p>	<p>2. Press 'STANDBY'.</p>	<p>3. Clean the ice cream head and machine with a brush and a clean cloth (preferably paper).</p>
		
<p>4. Disinfect the ice cream head with 80% alcohol spray.</p>		

5.3.2 Switching off & pasteurising

<p>1. Press 'OFF'.</p>	<p>2. Press 'PASTEURISING'. The ice cream mix will now be pasteurised and the machine will then switch to 'stand-by' mode.</p>	<p>3. Clean the ice cream head and machine with a brush and a clean cloth (preferably paper).</p>
<p>4. Disinfect the ice cream head with 80% alcohol spray.</p>		

5.4 Emergency stop

The machine must be switched off immediately if people or machinery are at risk:

- **Press** the emergency stop button.
The entire machine stops immediately and the power is turned off. The emergency circuit is now in operation.

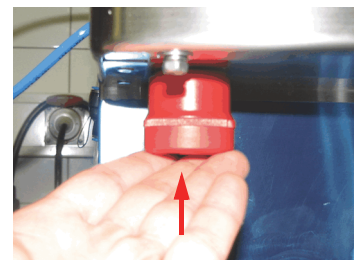

Press the emergency stop button immediately if people or machinery are at risk.

Resetting

Resetting the emergency stop button:

- **Rotate** the emergency stop button a quarter turn.
The machine can now be started up again.



First check why the emergency stop button was pressed. And remedy the problem.

5.5 Switching on/off

The machine does not have an on/off button. To switch off the machine completely:

1. **Press** the emergency stop button.
2. **Pull** the plug out of the socket.

To switch on the machine:

1. **Insert** the plug in the socket.
2. **Reset** the emergency stop feature.





Do not switch off the machine at the end of the day; set it to 'PASTEURISING' or 'STANDBY'.

5.6 Adjusting the viscosity

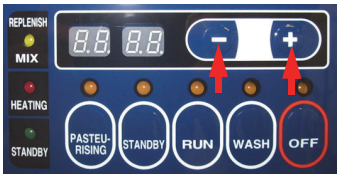

Use this function only during 'Run'.

The viscosity can be adjusted in half increments. On the display this is shown with a (dot) after the last digit. For example, 1.6. is half more than 1.6

		
<p>1. Press '-' and '+' together until the display flashes. The display on the right now shows the set value.</p>	<p>2. Press '+' or '-' to increase or decrease the viscosity.</p>	<p>3. Wait approximately 5 seconds. The display on the right now shows the new set value.</p>

6 Faults

6.1 Introduction



You will probably be able to resolve some of the faults yourself without difficulty. First try to remedy faults yourself using the instructions in this manual before contacting the dealer.

6.2 Messages on display

The following messages can appear on the display:

Message	Problem
E02	Overloading of the cooling compressor.
E03	Machine cannot discharge the hot air.
E04	Overloading of the mixing apparatus motor.
E05	Temperature does not rise during pasteurising.
E06	Temperature in the cylinder is too high during pasteurising.
E07	Temperature in the mix tank is too high during pasteurising.
E08	Temperature in the cylinder is too high during defrosting.
E09	Overheating of the cooling compressor.
E10	Microswitch of the piston stays operated. Close the piston completely with the dispensing handle.
E11	Measurement error of temperature sensor H in cylinder.
E12	Measurement error of temperature sensor F in cylinder.
E13	Measurement error of temperature sensor G.
LO	Balance in cylinder disturbed; see faults table for remedies.

Resetting error messages

To reset an error message, switch off the machine using the emergency stop button, wait 10 seconds and switch the machine back on (see chapter 5.4 - 'Emergency stop' on page 20).



If the error message remains, please contact the dealer.

6.3 How can I get the best yield from the machine

The machine must be running at a stable speed with a constant air/mix balance in order to achieve the best yield. If this air/mix balance is not constant, your ice cream will be soft or wet or your machine will make a rasping sound, you will experience a popping from the tap opening or the machine's display will show the indication LO. If one of these situations occurs, you should first check that the XL pump is still functioning properly before changing any of the machine's settings.

6.3.1 How can I check whether the XL pump is not causing a malfunction

The proper functioning of the XL pump is easy to check by then carrying out the following two actions:

1. Place a drop of water on the nozzle and draw off a tiny piece of ice cream. The drop of water should now be drawn into the nozzle valve.
2. Draw off a normal ice cream. The pump should stop within two-to-three strokes.

If this is not so in one or both of these cases, you should first remove the XL pump from the machine and clean it in accordance with chapter 7.3.13.

After replacing the XL pump in the machine, you should first draw off 20-to-25 ice creams before you can judge the result.

6.3.2 What should I do with a soft or wet and watery ice cream

A soft or wet and watery ice cream is normally caused by too little air in the ice cream. In some cases, too high a temperature of the ice cream, above -5°C can also make the ice cream soft or wet and watery. You should then carry out the following steps in order to make your ice cream a little drier and firmer:

1. Measure the temperature of your ice cream. If it is over -5°C , you should increase the viscosity by half a point (see chapter 5.6).
2. If the temperature of the ice cream is below -5°C , check first if the hole in the nozzle on the nozzle valve is blocked. If this is the case, clean the nozzle thoroughly and replace the nozzle on the nozzle valve. The air/mix balance will then be restored and drawing off 20-to-25 ice creams will improve the quality of the ice cream.

If the soft or wet and watery ice cream was not caused by point 1 or 2, you should place a nozzle with a larger hole onto the nozzle valve.

The nozzles in your sparepart box go up in steps of 5. You should place the nozzle with the next higher number onto the nozzle valve. If for example, you use nozzle 70, you should fit nozzle 75.

The air/mix balance will then be improved automatically and drawing off 20-to-25 ice creams will improve the quality of the ice cream. If you do not see any improvement after drawing off 20-to-25 ice creams, place the next higher nozzle and repeat this process until you are able to draw off a dry and firm ice cream.

6.3.3 What should I do in case of rasping, popping or if the machine displays LO

Rasping, popping or LO in the display is almost always due to too much air in the cylinder. This leads to free air bubbles in the cylinder that pop out of the ice cream machine when drawing off an ice cream. You can solve this by placing a nozzle with a smaller hole onto the nozzle valve.

The nozzles in your sparepart box go down in steps of 5. You should place the nozzle with the next lower number from your sparepart box onto the nozzle valve. If for example, you use nozzle 80, you should fit nozzle 75.

The air/mix balance will then automatically improve and the rasping, popping or the LO in the display will be reduced or stop after drawing off 20-to-25 ice creams. If you do not see any improvement after drawing off 20-to-25 ice creams, place the next lower nozzle and repeat this process until there is no more rasping, popping or LO in the display.

6.4 Faults table

Problem	Cause	Remedy
LO appears in the right-hand display.	Too much air in the cylinder.	See chapter 6.3.3 'What should I do in case of rasping, popping or if the machine displays LO'.
The 'AIR' light is flashing.	The pressure in the cylinder is too low, the XL pump is malfunctioning.	Release the pressure of the cylinder. Remove, clean and disinfect the XL pump Reinstall the the XL pump, pressurise the cylinder and start up the machine.
Machine is not responding and no lights are lit up.	The emergency stop button has been pressed.	Reset the emergency stop feature.
	Fuse(s) in meter box is (are) faulty.	Replace fuse(s) in the meter box.
	Phase fault protection relay is energized.	Incorrect phase connection in the meter box.
Scraping and popping.	Too much air in the cylinder.	See chapter 6.3.3 'What should I do in case of rasping, popping or if the machine displays LO'.
The ice cream is too soft (not caused by excessive sales).	Not much air in the ice cream (not caused by few sales over a long period).	See chapter 6.3.2 'What should I do with a soft or wet and watery ice cream'.
The machine is vibrating abnormally.	The power supply is disrupted or drive belt(s) is (are) faulty.	Please contact the dealer.
Ice cream is leaking through behind the ice cream head.	The components have not been fitted correctly (cap nuts are loose).	Fit the components properly. Check whether the nozzle and nozzle tube are clean.
	Gasket is worn	Check and replace if necessary.

Problem	Cause	Remedy
<p>The green 'STANDBY' light does not light up after pasteurising. The display should show</p>  <p>after pasteurising.</p>	Mix tank agitator not working (error message EO5).	Check whether agitator is turning (it should turn on every 3-to-4 minutes). If not, please contact the dealer.
	Mix tank lid does not close properly (heat loss) (error message EO5).	Fit mix tank lid properly.
	The 'OFF' light is lit. There was a power failure that turned off the whole machine.	In case yes, empty the machine completely and clean and disinfect the whole machine. In case no, pasteurise the machine before use.

7 Maintenance

7.1 Safety instructions

- Do not use a water hose or high-pressure cleaner to spray the machine clean.
- Clean and disinfect the machine at least once every six weeks with the recommended cleaning and disinfecting agents.
- Decalcify the machine every 2nd till 4th cleaning depending on the pollution, but atleast twice a year.
- Use prescribed lubricants only.



Maintenance work may only be carried out by trained staff.



Regular maintenance ensures good-quality ice cream and a properly functioning machine.

7.2 General instructions

The machine must be cleaned and disinfected at least once every six weeks. Between 2 to 2.5 hours are needed for this. Below are a number of general instructions for how to clean and disinfect the machine correctly.

7.2.1 Requirements

The following items are needed when cleaning the machine:

- Buckets & brushes
- Tea towel or kitchen roll
- Cleaning agent (recommended: Nissei Cip Clean)
- Disinfecting agent (recommended: Nissei Algides)
- O ring remover and piston puller
- 80% alcohol spray
- Lubricant (Petrogel)



The amount of Petrogel on the saucer is enough to lubricate all the parts of the machine.



Every 2nd till 4th cleaning depending on the pollution:

- Decalcify agent (recommended: Nissei Descaler)

7.2.2 Preventive maintenance

Preventive maintenance can be carried out by the operator when cleaning the machine.

The following parts must be checked:

- Rubbers and O rings of the XL pump and ice cream head.
We advise you to replace these twice a year.
- Scraper blades of the cylinder beater. These must be sharp enough to scrape the ice from the cylinder wall.
We advise you to replace these once a year.



Contact the dealer to order spareparts.



Always replace all O rings together.



The O rings can only be order in a complete set. See annex 2 on page 50 for the product number.

7.2.3 Cleaning and disinfecting

We advise to use to use cleaning agent and disinfecting agent mentioned below:

- Cleaning agent: Nissei Cip Clean
- Disinfecting agent: Nissei Algides

When cleaning and disinfecting all components:

- **Rinse** away as much ice cream mix as possible with cold water.
- **Clean** further with brush and cleaning solution and allow the components to stand in the cleaning solution for 5 minutes.
- **Rinse** thoroughly with lukewarm water. (2x)
- **Place** the components in the disinfecting solution for 5 minutes.
- **Rinse** thoroughly with cold water. (2x)



Clean and disinfect your hands thoroughly with alcohol 80% before touch disinfected parts.

- **Dry** the components as much as possible with a clean towel (preferably paper).
- **Place** the parts on a clean tea towel or sheet of kitchen paper.

Cleaning solution

- **Make** a solution of 100 ml. Nissei Cip Clean and 10 litres of warm water in a clean bucket.



During cleaning, regularly change the cleaning solution.

Disinfecting solution

- **Make** a solution of 125 ml. Nissei Algides and 10 litres of cold water in a clean bucket.



During disinfecting, regularly change the disinfecting solution.

7.2.4 Decalcify

The machine, the cylinder beater and all cleaned stainless steel parts of the mixpump must be decalcified every 2nd till 4th cleaning depending on the pollution, but at least twice a year. We advice to use to use the decalcify agent mentioned below:

- Decalcify agent: Nissei Descaler



Decalcify the machine, the cylinder beater and all cleaned stainless steel parts of the mixpump every 2nd till 4th cleaning depending on the pollution, but at least twice a year.

Decalcify solution

- Make a solution of 1 liter Nissei Descaler and 10 litres of cold water.

7.3 (Dis)assembling, cleaning and disinfecting the machine.



Please read the general instructions on cleaning and disinfecting before starting.

7.3.1 Procedure

(Dis)assembling, cleaning and disinfecting the machine is an intensive task. The following sequence is recommended for an effective procedure:

1. Defrost and drain cylinder.
2. Remove XL pump and mix tank agitator.
3. Drain mix tank.
4. Clean mix tank and cylinder.
5. Decalcify the machine (every 4th cleaning, but at least twice a year).
6. Remove ice cream head.
7. (Dis)assemble, clean and disinfect ice cream head.
8. (Dis)assemble, clean and disinfect cylinder beater and cream seal.
9. Fit ice cream head.
10. Disinfect machine.
11. Clean, rinse and disinfect XL pump parts.
12. Start up machine.



For optimum hygiene, it is recommended that you start the machine up with new ice cream mix. Do not use old ice cream mix.

7.3.2 Defrosting and draining cylinder

<p>1. Press 'OFF'.</p>	<p>2. Press 'PASTEURISING'.</p>	<p>3. Wait 10 minutes.</p>
<p>4. Press 'OFF'.</p>	<p>5. Press the emergency stop button.</p>	<p>6. Wait 10 seconds.</p>
<p>7. Reset the emergency stop feature.</p>	<p>8. Draw the ice cream mix out of the cylinder. Continue drawing product until there is no more pressure behind the ice cream mix.</p>	



Throw away the old ice cream mix. Do NOT re-use.

7.3.3 Removing XL pump and mix tank agitator



Make sure there is no more pressure in the cylinder before removing the XL pump from the mix tank.

<p>1. Disconnect the air hoses.</p>	<p>2. Remove the XL pump. Click the pump loose by rotating it anti-clockwise and then pull it straight upwards.</p>	<p>3. Place an air hose over the two air tubes.</p>
<p>4. Remove the agitator cap.</p>	<p>5. Remove the agitator.</p>	

7.3.4 Draining the mix tank.

<p>1. Press 'WASH'.</p>	<p>2. Drain all ice cream mix from the machine.</p>	<p>3. Press 'OFF'.</p>



Throw away the old ice cream mix. Do NOT re-use.

7.3.5 Cleaning the mix tank and cylinder

<p>cold water</p>		
<p>1. Fill the mix tank completely with cold water.</p>	<p>2. Press 'WASH'.</p>	<p>3. Clean the mix tank.</p>
		<p>cleaning solution</p>
<p>4. Press 'OFF'.</p>	<p>5. Drain all the water out of the machine.</p>	<p>6. Fill the mix tank completely with a cleaning solution and clean the mix tank.</p>
		<p>5 min</p>
<p>7. Clean the mix tank.</p>	<p>8. Press 'WASH'.</p>	<p>9. Wait 5 minutes.</p>
		<p>lukewarm water</p>
<p>10. Press 'OFF'.</p>	<p>11. Drain all cleaning solution out of the machine.</p>	<p>12. Fill the mix tank with clean lukewarm water.</p>

<p>13. Press 'WASH'.</p>	<p>14. Wait 5 minutes.</p>	<p>15. Press 'OFF'.</p>
<p>16. Drain all the water out of the machine.</p>	<p>17. Repeat steps 12 to 16.</p>	



Do not return the XL pump to the mix tank yet. This is done during start up.







7.3.6 Decalcify the machine





Decalcify the machine every 2nd till 4th cleaning depending on the pollution, but at least twice a year.



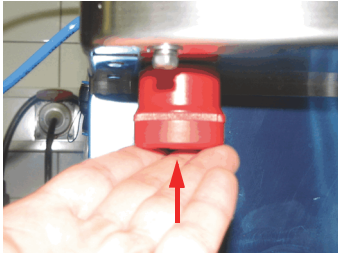

Place all the cleaned stainless steel parts of the mix pump in the mix tank so these are decalcified too.

 <p>decalcify solution</p>	 <p>10 min</p>	
<p>1. Fill the mix tank completely with decalcify solution.</p>	<p>2. Wait for at least 10 minutes.</p>	<p>3. Drain all the decalcify solution out of the machine.</p>
 <p>cold water</p>		 <p>cold water</p>
<p>4. Fill the mix tank completely with cold water.</p>	<p>5. Drain all the water out of the machine.</p>	<p>6. Repeat steps 4 to 5.</p>

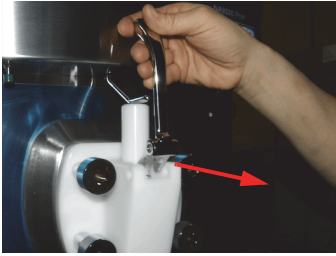
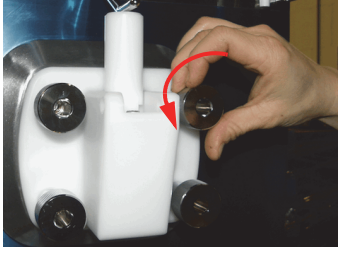
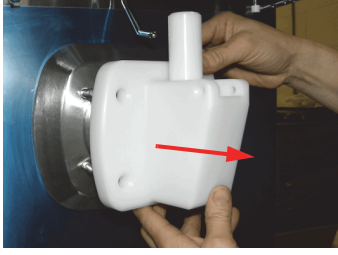

7.3.7 Removing the ice cream head

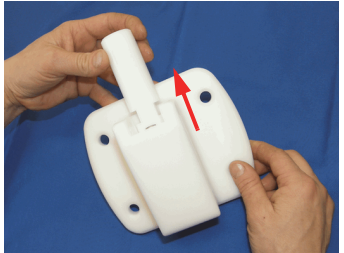
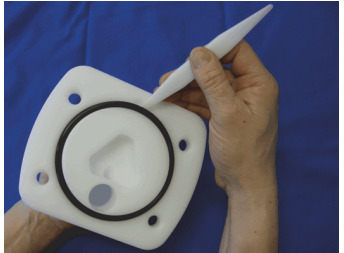
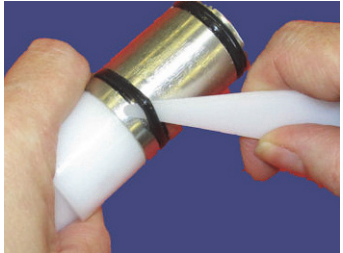
		
<p>1. Press the 'emergency stop' so the machine is shut down completely.</p>	<p>2. Remove the locking pin from the dispensing handle.</p>	<p>3. Remove the dispensing handle.</p>
		
<p>4. Loosen the four bolts.</p>	<p>5. Remove the ice cream head from the machine.</p>	

7.3.8 Disassembling, cleaning and disinfecting the ice cream head

		
<p>1. Push the piston out of the ice cream head.</p>	<p>2. Remove the gasket on the back of the ice cream head.</p>	<p>3. Remove the two O rings from the piston.</p>
 <p>reinigen en disinfecteren</p>		
<p>4. Clean and disinfect all components and dry them carefully with a clean towel (preferably paper). (See paragraph 7.2.3)</p>		

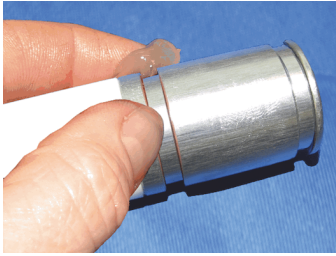

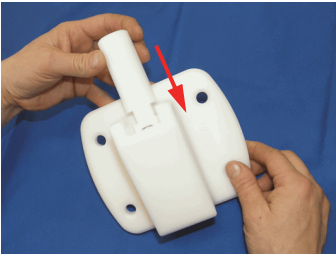
7.3.9 Fitting the ice cream head

		
1. Lubricate the O rings for the piston.	2. Lubricate the grooves for the O-rings.	3. Fit the two O rings on the piston.
		
4. Fit the piston in the ice cream head.		

7.3.10 (Dis)assembling, cleaning and disinfecting the cylinder beater

		
<p>1. Remove the beater from the cylinder. (Be careful not to drop the scraper blades onto the ground.)</p>	<p>2. Remove the cream seal from the drive shaft at the back of the cylinder.</p>	<p>3. Clean the (outside of) the cylinder.</p>
		
<p>4. Disassemble the beater.</p>	<p>5. Clean and disinfect all components and dry them carefully with a clean towel (preferably paper). (See paragraph 7.2.3)</p>	<p>6. Lubricate the cream seal.</p>
		
<p>7. Fit the cream seal to the drive shaft.</p>	<p>8. Assemble the beater.</p>	<p>9. Insert the beater in the cylinder.</p>

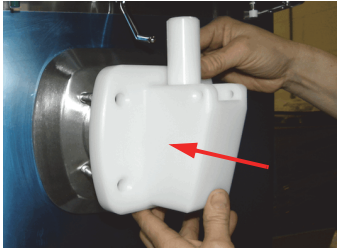
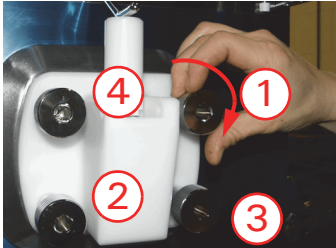
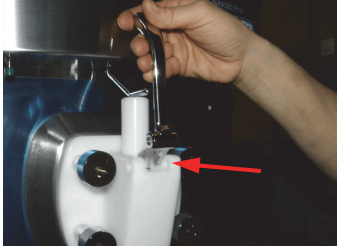
7.3.11 Fitting the ice cream head

		
<p>1. Attach the gasket to the back of the ice cream head. DO NOT lubricate it!</p>	<p>2. Place the combi-head on the machine. (Be careful! The pin for the headprotection must be pressed upwards. Place the combi-head in front of the cylinder correctly.)</p>	<p>3. Loosely tighten the four bolts in the sequence shown. Then tighten firmly by hand following the same sequence.</p>
		
<p>4. Fit the dispensing handle in the ice cream head.</p>	<p>5. Reattach the locking pin for the dispensing handle.</p>	

7.3.12 Disinfecting the machine

<p>disinfecting solution</p>	<p>5 min</p>	
<p>1. Fill the mix tank completely with disinfecting solution..</p>	<p>2. Wait at least 5 minutes.</p>	<p>3. Drain all the disinfecting solution out of the machine.</p>
<p>cold water</p>		<p>cold water</p>
<p>4. Fill the mix tank completely with cold water.</p>	<p>5. Drain all the water out of the machine.</p>	<p>6. Repeat steps 4 to 5.</p>

7.3.13 (Dis)assembling, cleaning and disinfecting the XL pump

<p>1. Pull the locking pins out of the pump.</p>	<p>2. Remove the pump foot from the pump.</p>	<p>3. Remove the nozzle tube.</p>
<p>4. Remove the nozzle from the tube.</p>	<p>5. Turn the piston puller in the piston.</p>	<p>6. Pull the piston out of the pump housing.</p>

<p>7. Remove the piston puller.</p>	<p>8. Loosen the top disc from the shaft.</p>	<p>9. Slide the middle disc from the shaft.</p>
<p>10. Remove the O rings from the outside of the discs.</p>	<p>11. Remove the O ring from the shaft.</p>	<p>12. Remove the two O rings on the inside of the middle disc.</p>
<p>13. Remove the three O rings from the pump foot.</p>	<p>14. Remove the valve hose from the pump foot.</p>	<p>15. Remove the mix valve from the pump foot.</p>
<p>cleaning and disinfecting</p>		
<p>16. Clean and disinfect all components and dry them carefully with a clean towel (preferably paper). (See paragraph 7.2.3)</p>	<p>17. Fit the valve hose to the pump foot. DO NOT lubricate it!</p>	<p>18. Fit the mix valve to the pump foot. DO NOT lubricate it!</p>

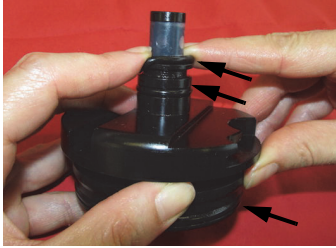
		
<p>19. Fit the 3 O rings to the pump foot. DO NOT lubricate it!</p>	<p>20. Lubricate all O rings with Petrogel.</p>	<p>21. Fit the thick O ring to the bottom disc.</p>
		
<p>22. Fit the O rings to the outside of the top disc.</p>	<p>23. Fit the two O rings to the outside of the middle disc.</p>	<p>24. Fit the O rings to the inside of the middle disc.</p>
		
<p>25. Fit the O ring to the shaft.</p>	<p>26. Lubricate the shaft.</p>	<p>27. Lubricate the inner O rings of the middle disc.</p>
		
<p>28. Slide the middle disc over the shaft. Attention, the big ring of the middle disc too the bottomside.</p>	<p>29. Turn the top disc onto the shaft.</p>	<p>30. Lubricate the O rings of the bottom and upper disc well once more.</p>

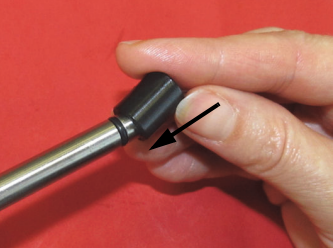
		
<p>31. Slide the middle disc against the bottom disc.</p>	<p>32. Fit the piston package into the pump housing. Push the piston package into the housing as far as it will go.</p>	<p>33. Fit the nozzle tube.</p>
		
<p>34. Attach the pump foot to the pump. Ensure a proper alignment of the nozzle behind the ridge.</p>	<p>35. Insert the locking pins through the pump housing.</p>	<p>36. Attach the nozzle to the tube.</p>



Do not return the XL pump to the mix tank yet. This is done during start up.

7.3.14 Starting up the machine

<p>1. Reset the emergency stop.</p>	<p>2. Press 'OFF'.</p>	<p>3. Fit the agitator.</p>
<p>4. Fit the agitator cap.</p>	<p>5. Fill the mix tank with 1,2 liter of ice cream mix.</p>	<p>6. Remove the air hose.</p>
<p>7. Install the XL pump in the mix tank.</p>	<p>8. Connect the air hoses.</p>	<p>9. Fill the mix tank with ice cream mix.</p>
<p>10. Press 'WASH'.</p>	<p>11. Push the dispensing handle for ice cream downwards until ice cream mix comes out of the ice cream head and the mix pump starts pumping.</p>	<p>12. Wait at least 10 minutes.</p>

<p>13. Press 'OFF'.</p>	<p>14. Press 'RUN'.</p>	<p>15. Wait until 2 horizontal lines are shown in the left display.</p>
<p>16. Dispense one or two ice creams, taste them and throw them away. The machine is now ready for use.</p>		



When dispensing product, air may still be expelled the first few times. This stops once a number of ice creams have been dispensed.

8 Transportation and Storage



Check that all connections have been disconnected before moving the machine.

8.1 Transportation

The following rules must be observed during transportation:

- Always transport the machine upright.
- Use suitable lifting gear. Do not lift the machine manually.



If necessary, have the machine transported by a specialist company. They have suitable lifting gear and transportation means.

8.2 Storage

The following rules must be observed during storage:

- First clean the machine thoroughly.
- Store the ice cream head and XL pump disassembled.
- The storage area must be dry with an air humidity level of 45-75%.
- The ambient temperature must be between 4°C and 50°C.
- The storage area must be free of dust or the machine and parts must be covered with plastic film.

9 Discarding

9.1 Environmental factors

The following must be observed:



When discharging the machine it must be handed in to an authorized waste collection point for electrical equipment.



Here the machine is disposed of in an environmentally friendly manner and materials are reused.



It must be taken into account that refrigerant gasses are present in the machine.

Annex 1 Specifications

Machine dimensions	
Height	750 mm 850 mm (including tap)
Width	440 mm
Depth	800 mm
Weight	Approx. 150 kg

Connection details	
Electrical	400 V 3 x 16 amp + N + PE
Water pressure	Min. 1 bar/max. 3 bar
Ambient temperature	+ 5°C to + 35°C

Consumption details	
Electrical	2 kWh
Cooling water	Approx. 40 m ³ /year

Specifications	
Dispensing capacity	Approx. 30 litres/hour
Soft ice cream flavours	1
Cylinder capacity	2.5 litres
Mix tank capacity	10 litres

Annex 2 Spare Parts

A2.1 Ice cream head and beater

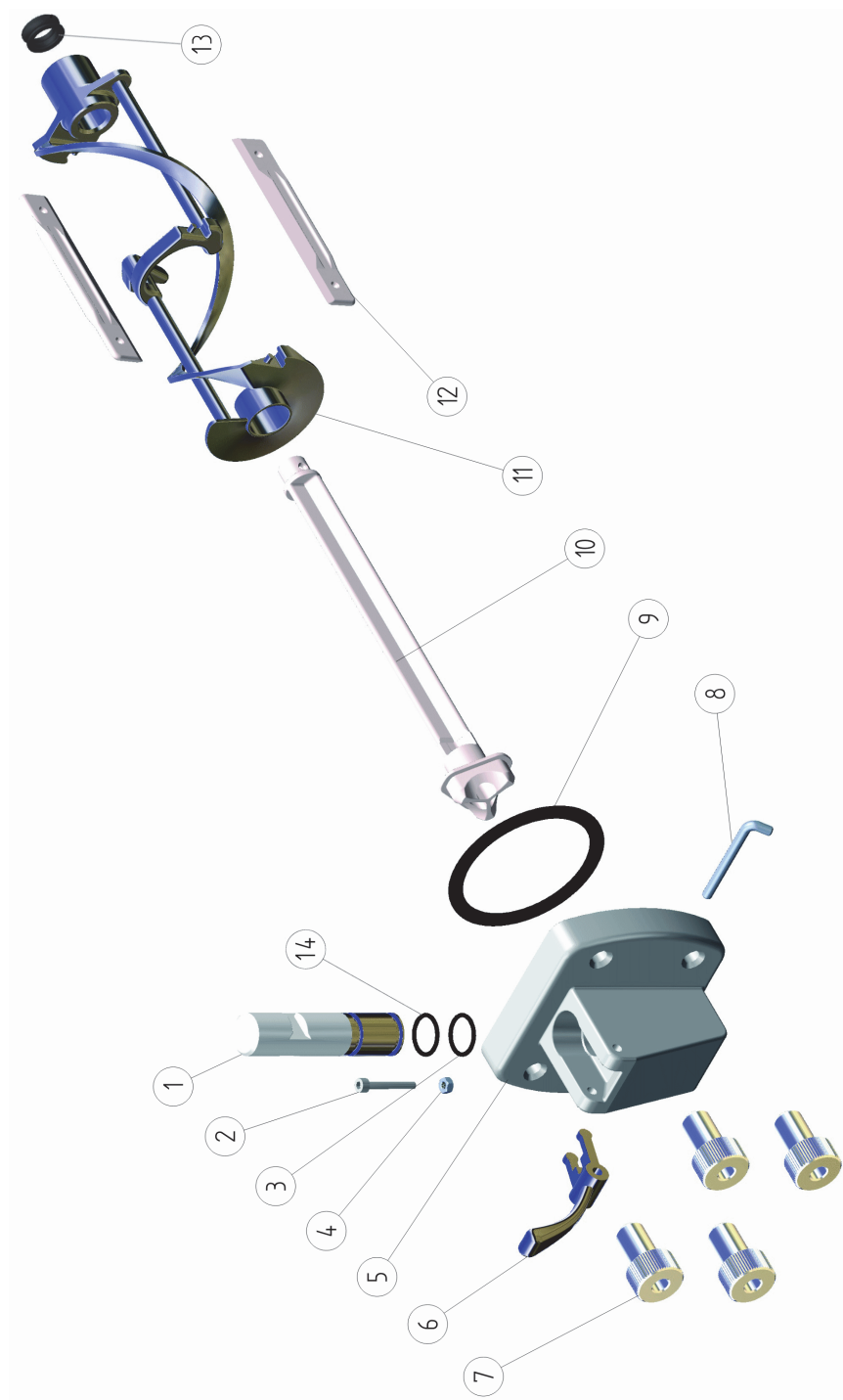

Item no.	Name	Quantity	Product no.
1	Piston	1	30009
2	Allen bolt, stainless steel M6 x 40	1	
3	O ring 23,55 x 3,2	1	35006
4	Nut, stainless steel M6	1	
5	Ice cream head	1	137664
6	Dispensing handle	1	137629
7	Head bolt, stainless steel	4	138044
8	Locking pin dispensing handle	1	31022
9	Gasket ø 95	1	138042
10	Center bar	1	30117
11	Cylinder beater ø 95	1	30053
12	Scraper blade double	2	30091
13	Cream seal	1	35000
14	O ring 23,55 x 3,2 (orange)	1	35006
	O ring set NA 9328 Prof XL pump XL pump	1	33104

A2.2 XL pump

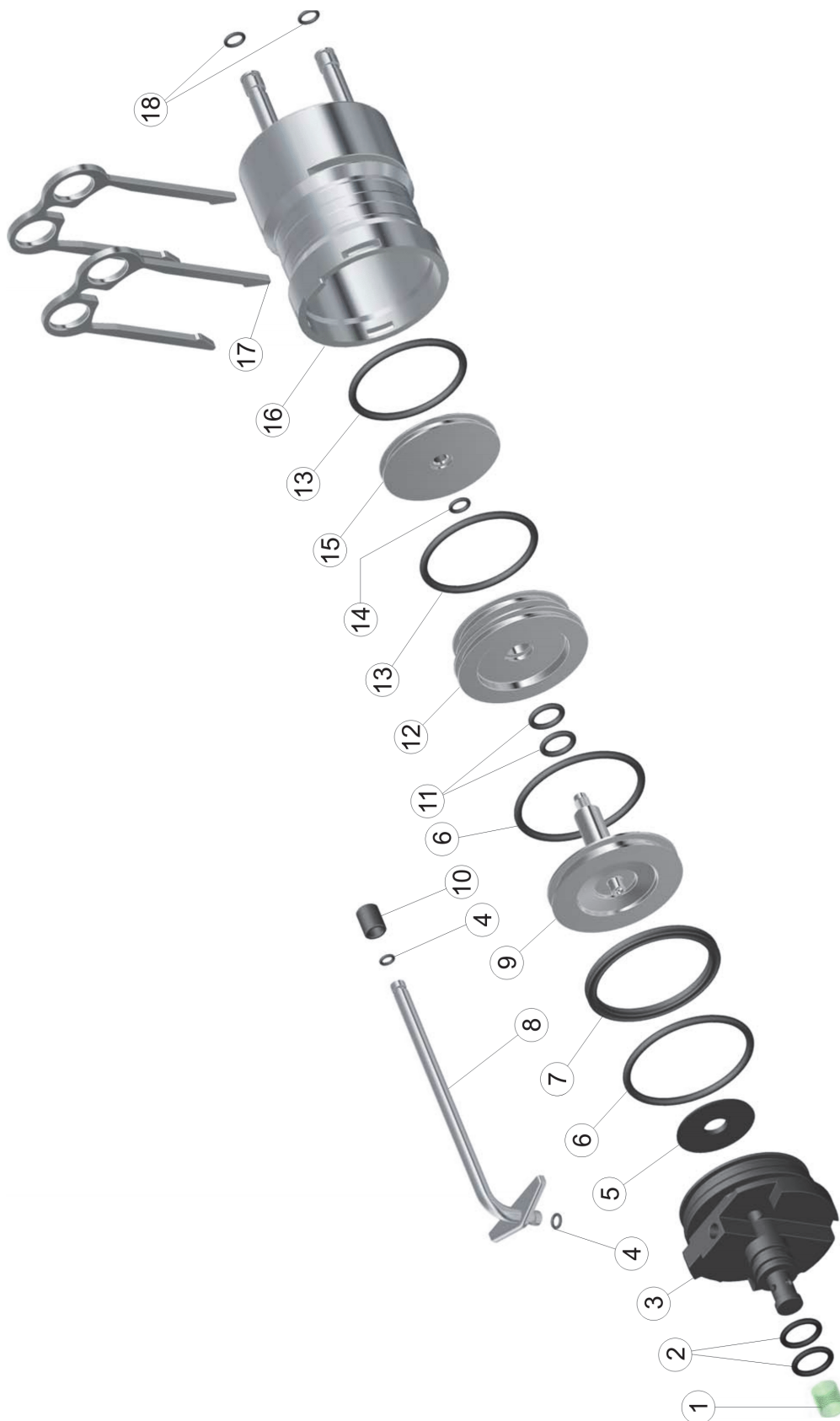

Item no.	Name	Quantity	Product no.
1	Valve hose 14mm	1	33475
2	O ring 17 x 3	2	35013
3	Pump foot	1	085046
4	O ring 5,1 x 1,6	2	35029
5	Mix pump valve	1	33409
6	O ring 64 x 4	2	35017
7	X ring 62,87 x 5,33	1	35016
8	Nozzle tube short	1	33492
9	Bottom piston	1	085039
10	Nozzle	1	400...(+ size)
11	O ring 14 x 3	2	35021
12	Middle piston	1	085042
13	O ring 57 x 4	2	35015
14	O ring 8 x 2	1	97010
15	Top piston	1	085040
16	Pump housing	1	085043
17	Locking pin	2	085044
18	O ring 7,65 x 1,78	2	33400
	O ring set XL pump	1	33111

Annex 3 EC Declaration

EC Declaration of Conformity of the Machinery Directive 2006/42/EC, Appendix II, under 1.A

Manufacturer,

Win Equipment B.V.
De Kronkels 31
3752 LM Bunschoten
The Netherlands



hereby declares that the following machine:

Name: Nissei soft ice cream machine
Type: NA 9328 Prof XL pump

is in conformance with the following EC directive:

- the Machinery Directive 2006/42/EC

and the following harmonised European standards:

- NEN-EN-ISO 12100-1/2
- NEN-EN-IEC 60204-1

Bunschoten, May 24th 2017

Name: M. Jocker
Position: Manager Operations